



RONDO-100 / RONDO-125

Bezrámový vetrací difúzor

Technická špecifikácia



reddot winner 2023

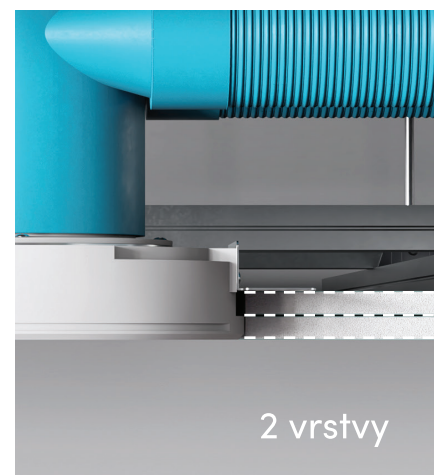
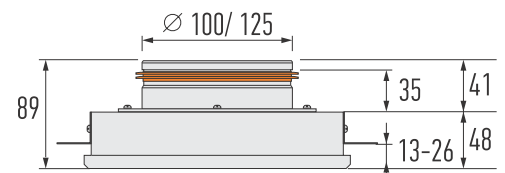
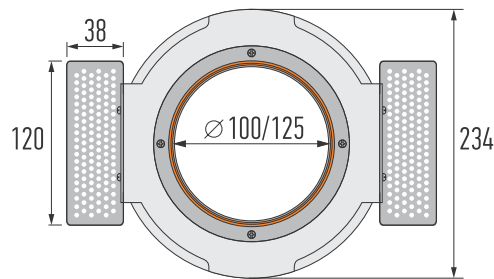
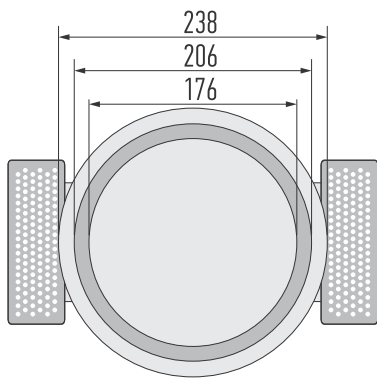

RONDO-100 / 125

Technické údaje



hidden air
diffusers

RONDO 100 (prívod vzduchu)

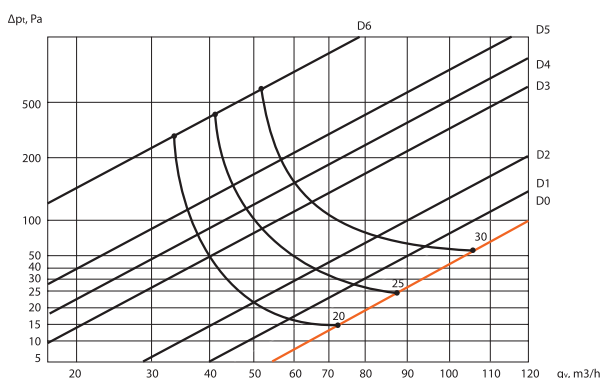

RONDO 125 (prívod vzduchu)

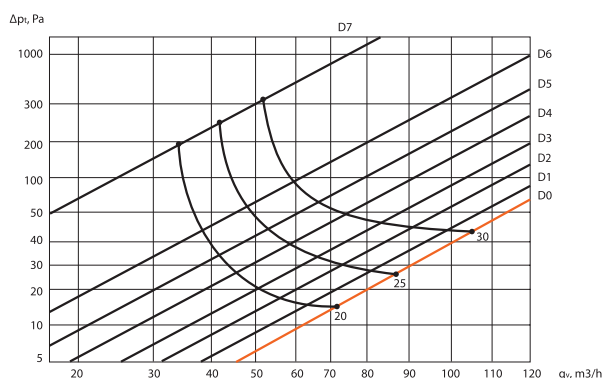

RONDO 100 (odvod vzduchu)

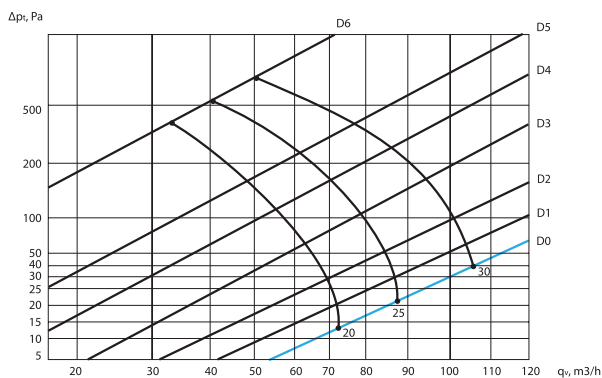

RONDO 125 (odvod vzduchu)

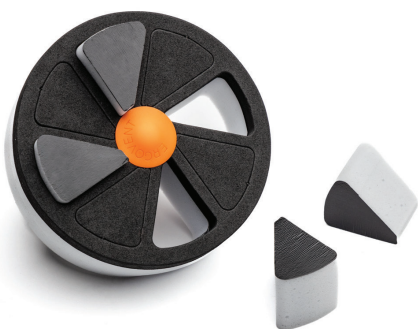
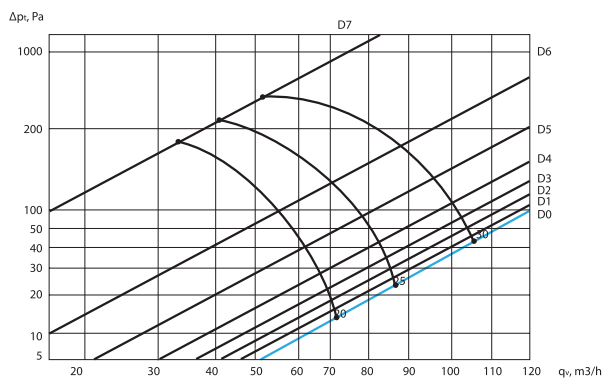

Na nastavenie prietoku vzduchu sa používa polyuretánová segmentová klapka

- D0 - bez vlozenej segmentovej klapky
- D1 - vložený 1 segment
- D2 - vložené 2 segmenty
- D3 - vložené 3 segmenty
- D4 - vložené 4 segmenty
- D5 - vložených 5 segmentov
- D6 - vložených 6 segmentov
- D7 - vložených 7 segmentov

RONDO 100/125
rýchlosť, m/s

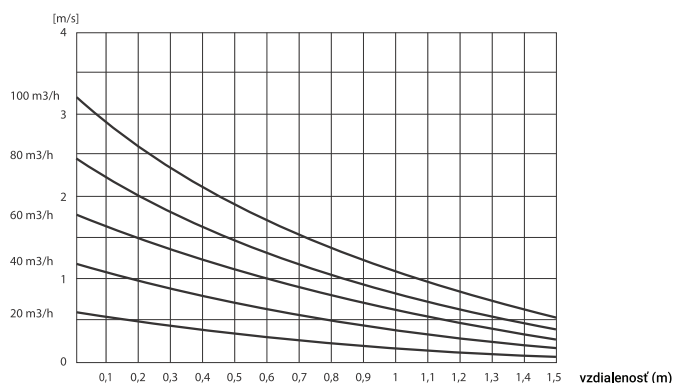

Nuskenúokite QR koda parsisišti montavimo instrukcija.